



A Professional Manufacturer of Display

Manufacturer Certificated



CERT. No.: 282Q19070712006



CERT. No.: 282E19070712007

Product Specification

Model: TOH216XST-01CG

2.16"AMOLED Display Module(480*480)

This module uses RoHS material

Tailor Pixels Technology Co., Ltd.

www.tailorpixels.com

tailor@tailorpixels.com

Ph: 86-755-8821 2653

Table of Contents 目录

1	General Description 规格简介.....	4
2	Module Parameter 模组参数.....	4
3	Mechanical Drawings 结构图.....	5
4	Module Interface 模组接口定义.....	6
5	Application Circuit 应用电路.....	6
6	Absolute Maximum Ratings 绝对最大额定值.....	7
7	Electrical Specification 电性规格.....	7
8	Initialization Code 初始化代码.....	8
9	Optical Specifications 光学规格.....	7
9.1	Optical Specifications 光学规格.....	
9.2	The power on/off sequence is illustrated below 电源启动/关闭顺序.....	9
9.3	Definition of Contrast Ratio 对比度的定义.....	9
9.4	Definition of Viewing Angles 视角的定义.....	9
9.5	Definition of Color Appearance 色域的定义.....	9
9.6	Definition of Surface Luminance, Uniformity and Transmittance.....	10
	表面亮度、均匀性和透光率的定义.....	10
10	Quality Assurance 质量标准.....	14
10.1	Purpose 目的.....	10
10.2	Agreement Items 协议项目.....	10
10.3	Standard of the Product Visual Inspection 产品外观检验标准.....	10
10.4	Inspection Specification 检验标准.....	11
10.5	Classification of Defects 缺陷的分类.....	15
10.6	Identification/marketing criteria 识别/评分标准.....	15
10.7	Packing 包装.....	15
11	Reliability Specification 可靠性规范.....	15
12	Precautions and Warranty 注意事项和保证.....	16
12.1	Safety 安全.....	16
12.2	Handling 处理.....	16
12.3	Operation 操作.....	16
12.4	Static Electricity 静电.....	17
12.5	Limited Warranty 有限质量保证.....	17
13	Packaging 包装.....	17
14	Prior Consult Matter 免责声明.....	17

1 General Description 规格简介

2.16 inch 480x480 is a color active matrix AMOLED module

This module has a 2.16 inch diagonally measured active area with 480x480 resolutions (480 horizontal by 480 vertical pixel arrays). Each pixel is divided into RED,

GREEN, BLUE dots and this module can display 16.7M colors.

2.16 英寸 480x480 是一个彩色有源矩阵 AMOLED 模块。该模块有一个 2.16 英寸的对角线测量的活动区域，分辨率为 480x480（480 水平和 480 垂直像素数组）。每个像素被分为红色、绿色、蓝点，该模块可以显示 16.7M 的颜色。

2 Module Parameter 模组参数

Features	Details	Unit
Display Size(Diagonal) 显示尺寸(对角线)	2.16	inch
显示屏类型	LTPS-AMOLED	-
Display Mode 显示模式	Transmissive OLED	-
Resolution 分辨率	480RGB x 480	-
Active Area 显示区	38.39(H) × 38.39(V)	mm
Module Outline 模组外形	40.29(H) × 41.09(V) × 0.8(T)	mm
Display Colors 显示颜色	16.7M	-
Interface 接口	QSPI/MIPI	-
Driver IC 驱动 IC	CO5300	-
TP Viewing Area TP 视窗	38.79(H) × 38.79(V)	mm
TP Outline(assembly) TP 外形	44.09(H) × 44.09(V) × 0.95(T)	mm
TP IC	CST9220	
Luminance on surface 亮度	700	cd/m ²
View Direction 视角方向	All	Best image
Contrast ratio 对比度	50000:1	
Color gamut 色域	108%	
PPI 图像点密集度	314	-
Window effect 视窗效果	-	-
Cover plate surface effect 盖板表面效果	-	-
Operating Temperature 工作温度	-20~70	°C
Storage Temperature 储存温度	-30~80	°C
Weight 重量	TBD	g

Note 1: Excluding hooks, posts , FPC/FPC tail etc.

3 Mechanical Drawings 结构

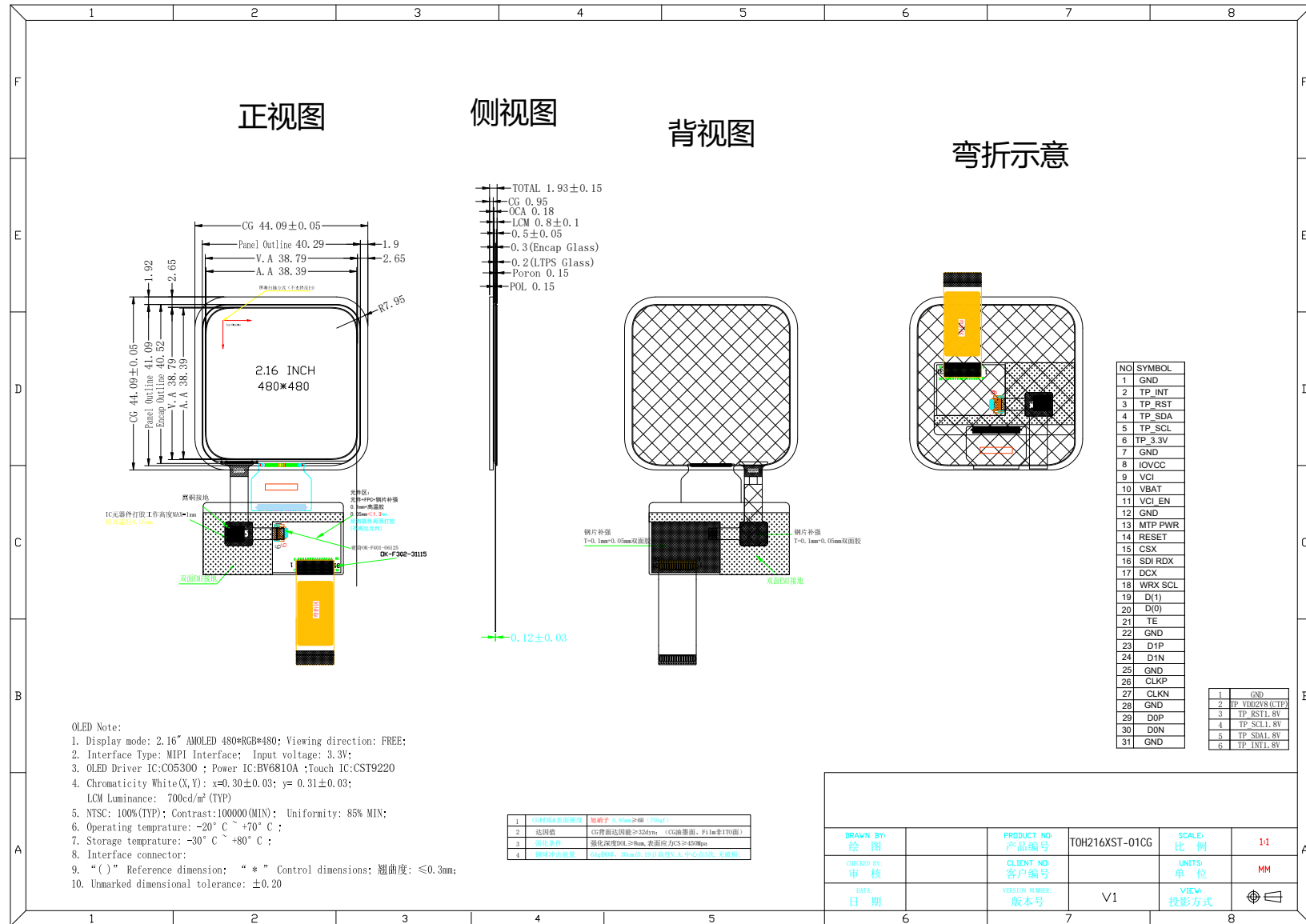

4 Module Interface 模组接口定义

NO	SYMBOL	FUNCTION
1	GND	Power Ground
2	TP_INT	Touch panel interrupt output
3	TP_RST	Touch panel reset
4	TP_SDA	Touch panel I2C data
5	TP_SCL	Touch panel I2C clock
6	TP 3.3	Touch panel Power output
7	GND	Power Ground
8	IOVCC	Power Supply for logic, VDDIO=1.8V~3.3V.
9	VCI	Power supply to DCDC power for DDIC use
10	VBAT	Power Input for SIBO VBAT=3.7~4.5V
11	VCI_EN	Power supply to DCDC power for DDIC use
12	GND	Power Ground
13	MTP PWR	MTP programming power supply pin. (8V typical) - Must be left open or connected to VSSD in normal condition.
14	RESET	- This signal will reset the device and must be applied to properly initialize the chip. Signal is active low.
15	CSX	chip select
16	SDI RDX	serial data input 0 / serial data output
17	DCX	serial data input 1
18	WRX SCL	- SCL: A synchronous clock signal in SPI I/F. - If not used, please connect to VSSI
19	D(1)	serial data input 3
20	D(0)	serial data input 2
21	TE	Tearing effect output pin to synchronize MCU to frame writing, activated by S/W command
22	GND	Power Ground
23	D1P	MIPI-DSI Data differential signal input pins.
24	D1N	MIPI-DSI Data differential signal input pins.
25	GND	Power Ground
26	CLKP	CLKP
27	CLKN	CLKN
28	GND	Power Ground
29	D0P	MIPI-DSI Data differential signal input pins.
30	D0N	MIPI-DSI Data differential signal input pins.
31	GND	Power Ground

6 Absolute Maximum Ratings 绝对最大额定值

Item 项目	Symbol	Min.最小	Max.最大	Unit 单位	
Supply Voltage 电源电压	Power supply	VCI	-0.3	+4.6	V
	Power supply	-	-	-	V
	IO	IOVCC	-0.3	+4.6	V
Input Voltage 输入电压	V_i	-0.3	IOVDD+0.3	V	
Storage temperature 储存温度	T_{stg}	-30	+80	°C	
Operating temperature 工作温度	T_{op}	-20	+70	°C	
Storage humidity 存储湿度	H_{stg}	10	Note 1	%RH	
Operating humidity 操作湿度	H_{op}	10	Note 1	%RH	

VSS=0V, Ta=25°C

Note 1: 90%RH max, If Ta is below 50°C; 60%RH max, If Ta is over 60°C.

7 Electrical Specification 电性规格

DC Characteristics 直流特性

Item 项目	Symbol	Min.最小	Typ.中间	Max.最大	Unit 单位	
Supply Voltage 电源电压	Power supply	VBAT	-	3.7	4.5	V
	Power supply	VCI	2.7	3.3	3.6	V
	IO	IOVCC	1.65	1.8	3.3	V
Logic Low input voltage 输入电压低	V_{IL}	-0.3IOVCC	-	0.3IOVCC	V	
Logic High input voltage 输入电压高	V_{IH}	0.7IOVCC	-	IOVCC	V	
Logic Low output voltage 输出电压低	V_{OL}	-	-	0.2IOVCC	V	
Logic High output voltage 输出电压高	V_{OH}	0.8IOVCC	-	-	V	
Current Consumption 电流消耗	Normal display 正常的显示	Ivdd	-	TBD	-	mA
	Standby mode 待机模式	Ivdd	-	TBD	-	uA
Frame Frequency 帧频	f_{FR}	-	60	-	Hz	

8 Initialization Code 初始化代码

9 Optical Specifications 光学规格

9.1 Optical Specifications 光学规格

Ta=25°C, VDD=2.8V, TN LC+ Polarizer

Item 项目	Symbol 标志	Condition 条件	Specification 规范			Unit 单位
			Min. 最小	Typ. 中间	Max. 最大	
Luminance on surface($I_f=20\text{mA}$) 表面亮度	L_v	Normally viewing angle	-	700	-	cd/m ²
Contrast ratio 对比度	CR	$\theta_x = \theta_y = 0^\circ$	50000	-	-	-
Response time 响应时间	TR	-	-	2	4	ms
	TF		-	2	4	
Chromaticity Transmissive 色度	Red 红	XR	0.643	0.683	0.723	-
		YR	0.274	0.314	0.353	-
	Green 绿	XG	0.19	0.24	0.29	-
		YG	0.678	0.728	0.778	-
	Blue 蓝	XB	0.108	0.138	0.168	-
		YB	0.009	0.046	0.079	-
	White 白	XW	0.280	0.300	0.320	-
		YW	0.290	0.310	0.330	-
Viewing Angle 视角	Horizo ntal	$\theta X+$	80	-	-	Deg.
		$\theta X-$	80	-	-	
	Vertical	$\theta Y+$	80	-	-	
		$\theta Y-$	80	-	-	
NTSC Ratio(Gamut)	-	-	97	108	-	%

9.2 The power on/off sequence is illustrated below 电源启动/关闭顺序

The Power on sequence is shown as below.

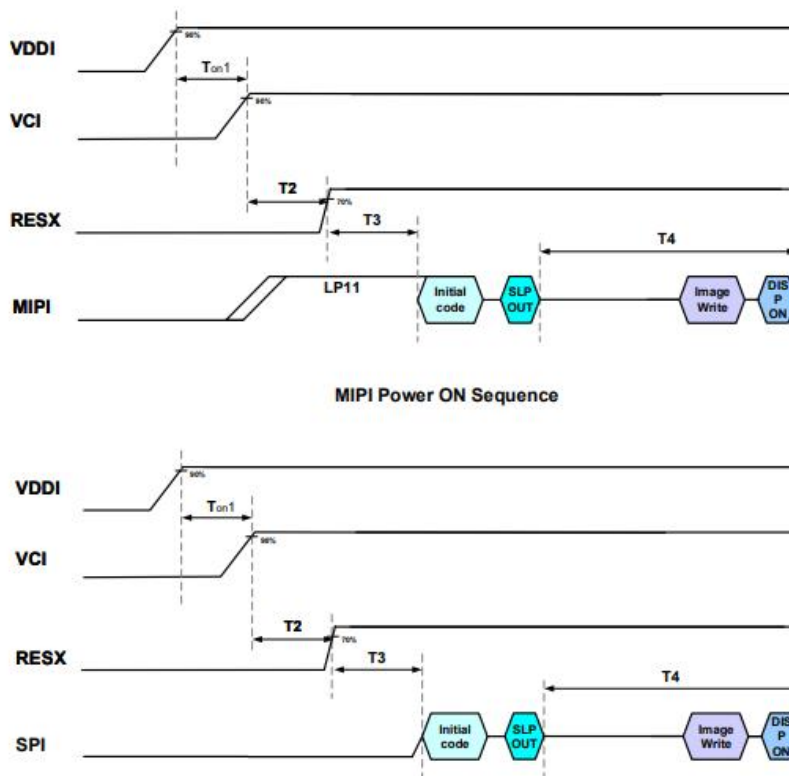

9.3 Definition of Contrast Ratio 对比度的定义

Contrast is measured perpendicular to display surface in reflective and transmissive mode. The measurement condition is:

Measuring Equipment 测量设备	BM-7 or EQUI
Measuring Point Diameter 测点直径	3mm//1mm
Measuring Point Location 测点位置	Active Area centre point
Test pattern 测试模式	A: All Pixels white
	B: All Pixel black
Contrast setting	Maximum

Definitions: CR (Contrast) = Luminance of White Pixel / Luminance of Black Pixel

9.4 Definition of Viewing Angles 视角的定义

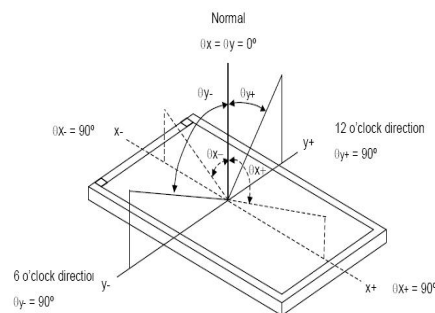

Measuring machine: LCD-5100 or EQUI

9.5 Definition of Color Appearance 色域的定义

R,G,B and W are defined by (x, y) on the IE chromaticity diagram

NTSC=area of RGB triangle/area of NTSC triangleX100%

Measuring picture: Red, Green, Blue and White (Measuring machine: BM-7)

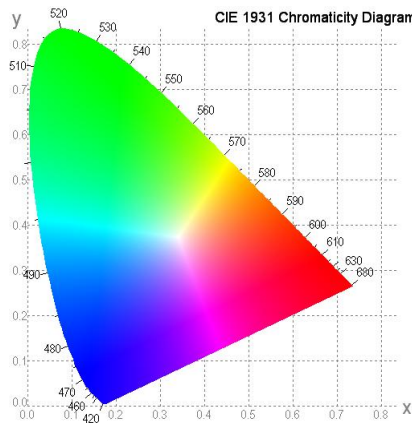

9.6 Definition of Surface Luminance, Uniformity and Transmittance

表面亮度、均匀性和透光率的定义

Using the transmissive mode measurement approach, measure the white screen luminance of the display panel and backlight.

9.6.1 Surface Luminance: $LV = \text{average (LP1:LP5)}$

9.6.2 Uniformity = $\text{Minimal (LP1:LP5) / Maximal (LP1:LP5) * 100\%}$

9.6.3 Transmittance = $LV \text{ on LCD} / LV \text{ on Backlight} * 100\%$

Note :Measuring machine:BM-7

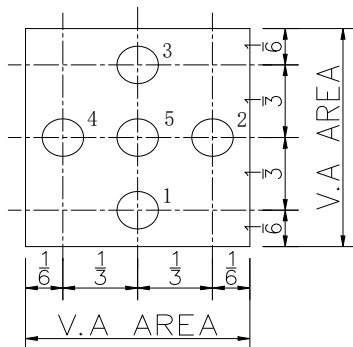

10 Quality Assurance 质量标准

10.1 Purpose 目的

This standard for Quality Assurance assures the quality of LCD module products supplied to customer by Tailorpixels .

10.2 Agreement Items 协议项目

Tailorpixels and customer shall negotiate if the following situation occurs:

10.2.1 Discrepancies between Tailorpixels 's QA standards and customer's QA standards.

10.2.2 Additional requirement to be added in product specification.

10.2.3 Any other special problem.

10.3 Standard of the Product Visual Inspection 产品外观检验标准

10.3.1 Appearance inspection:

10.3.1.1 The inspection must be under illumination about 1000 – 1500 lx, and the distance of view must be at 30cm ± 2cm.

10.3.1.2 The viewing angle should be 45° from the vertical line without reflection light or follows customer's viewing angle specifications.

10.3.1.3 Definition of area: A Zone: Active Area, B Zone: Viewing Area.

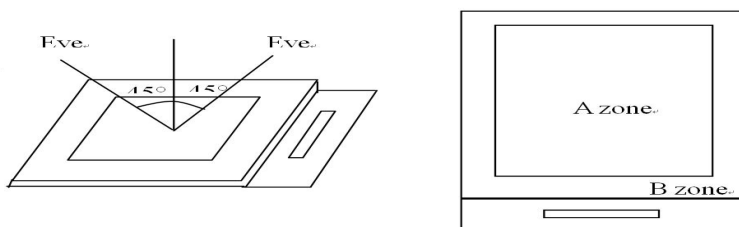

10.3.2 Basic principle: A set of sample to indicate the limit of acceptable quality level must be discussed by both Tailorpixels and customer when there is any dispute happened.

10.4 Inspection Specification 检验标准

Sampling plan according to GB/T2828.1-2012/ISO 2859-1: 1999 and ANSI/ASQC



Z1.4-1993, normal level 2 and based on:

Major defect: AQL 0.4

Minor defect: AQL 1.0

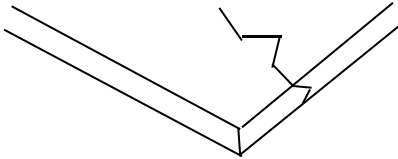
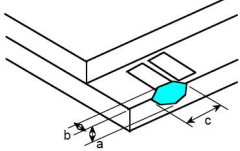
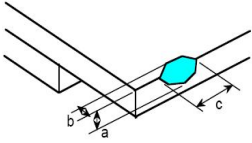
No.	Item 项目	Criteria (Unit: mm) 标准												
01	Black / White spot Foreign material (Round type) Pinholes Stain Particles inside cell. (Minor defect) 黑/白斑/异物 (圆类型)细胞内的针孔染色颗粒。(小瑕疵)	 $\phi = (a + b) / 2$ Distance between 2 defects should more than 10mm apart. <table border="1" style="float: right;"> <thead> <tr> <th>Area</th> <th>Acc. Qty</th> </tr> </thead> <tbody> <tr> <td>Size $\phi \leq 0.10$</td> <td>Ignore</td> </tr> <tr> <td>$0.10 < \phi \leq 0.2$</td> <td>2</td> </tr> <tr> <td>$0.2 < \phi$</td> <td>0</td> </tr> <tr> <td>Total</td> <td>$N \leq 3$ NO include $\phi \leq 0.10$</td> </tr> </tbody> </table>	Area	Acc. Qty	Size $\phi \leq 0.10$	Ignore	$0.10 < \phi \leq 0.2$	2	$0.2 < \phi$	0	Total	$N \leq 3$ NO include $\phi \leq 0.10$		
Area	Acc. Qty													
Size $\phi \leq 0.10$	Ignore													
$0.10 < \phi \leq 0.2$	2													
$0.2 < \phi$	0													
Total	$N \leq 3$ NO include $\phi \leq 0.10$													
02	Black and White line Scratch Foreign material (Line type) (Minor defect) 黑白线刮伤异物(类型)行 (小瑕疵)	 <table border="1" style="float: right;"> <thead> <tr> <th>Length</th> <th>Width</th> <th>Acc. Qty</th> </tr> </thead> <tbody> <tr> <td>/</td> <td>$W \leq 0.03$</td> <td>Ignore</td> </tr> <tr> <td>$L \leq 3$</td> <td>$0.05 < W \leq 0.08$</td> <td>2</td> </tr> <tr> <td>/</td> <td>$0.08 < W$</td> <td>0</td> </tr> </tbody> </table>	Length	Width	Acc. Qty	/	$W \leq 0.03$	Ignore	$L \leq 3$	$0.05 < W \leq 0.08$	2	/	$0.08 < W$	0
Length	Width	Acc. Qty												
/	$W \leq 0.03$	Ignore												
$L \leq 3$	$0.05 < W \leq 0.08$	2												
/	$0.08 < W$	0												

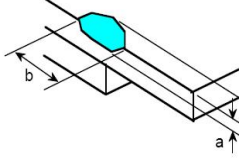
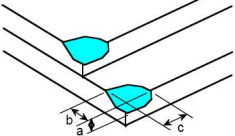
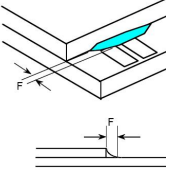
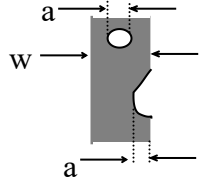
No.	Item 项目	Criteria (Unit: mm) 标准										
		<table border="1" data-bbox="635 168 1259 217"> <tr> <td data-bbox="635 168 1117 217">Total</td> <td data-bbox="1117 168 1259 217">N ≦ 2</td> </tr> </table> <p data-bbox="587 472 1342 602">Distance between 2 defects should more than 10mm apart. Scratches not viewable through the back of the display are acceptable.</p>	Total	N ≦ 2								
Total	N ≦ 2											
03	<p data-bbox="260 748 560 875">Glass Crack (Minor defect) 玻璃裂 纹(小瑕疵)</p>	 <p data-bbox="587 864 1433 994">LCD with extensible crack line is unacceptable(When press the cracked LCD area, the line will expand, we define it is extensible crack line)</p>										
04	<p data-bbox="260 1014 539 1193">Glass Chipping Pad Area: (Minor defect) 玻璃碎片面积:(轻微 缺陷)</p> 	<table border="1" data-bbox="775 1088 1246 1189"> <tr> <th data-bbox="775 1088 1058 1137">Length and Width</th> <th data-bbox="1058 1088 1246 1137">Acc. Qty</th> </tr> <tr> <td data-bbox="775 1137 1058 1189">c < 5.0, b < 0.4</td> <td data-bbox="1058 1137 1246 1189">Ignore</td> </tr> </table>	Length and Width	Acc. Qty	c < 5.0, b < 0.4	Ignore						
Length and Width	Acc. Qty											
c < 5.0, b < 0.4	Ignore											
05	<p data-bbox="260 1458 555 1688">Glass Chipping Rear of PadArea:(Minor defect) 玻璃切屑垫区后方: (小瑕疵)</p> 	<table border="1" data-bbox="775 1480 1246 1733"> <tr> <th data-bbox="775 1480 1058 1529">Length and Width</th> <th data-bbox="1058 1480 1246 1529">Acc. Qty</th> </tr> <tr> <td data-bbox="775 1529 1058 1581">c > 3.0, b < 1.0</td> <td data-bbox="1058 1529 1246 1581">1</td> </tr> <tr> <td data-bbox="775 1581 1058 1632">c < 3.0, b < 1.0</td> <td data-bbox="1058 1581 1246 1632">2</td> </tr> <tr> <td data-bbox="775 1632 1058 1684">c < 3.0, b < 0.5</td> <td data-bbox="1058 1632 1246 1684">4</td> </tr> <tr> <td colspan="2" data-bbox="775 1684 1246 1733">a < Glass Thickness</td> </tr> </table>	Length and Width	Acc. Qty	c > 3.0, b < 1.0	1	c < 3.0, b < 1.0	2	c < 3.0, b < 0.5	4	a < Glass Thickness	
Length and Width	Acc. Qty											
c > 3.0, b < 1.0	1											
c < 3.0, b < 1.0	2											
c < 3.0, b < 0.5	4											
a < Glass Thickness												

No.	Item 项目	Criteria (Unit: mm) 标准								
06	Glass Chipping Except Pad Area: (Minor defect) 除垫区外的玻璃切屑:(小瑕疵) 	<table border="1" data-bbox="775 248 1246 398"> <thead> <tr> <th>Length and Width</th> <th>Acc. Qty</th> </tr> </thead> <tbody> <tr> <td>$c \leq 0.6, b < 5.0$</td> <td>Ignore</td> </tr> <tr> <td colspan="2" style="text-align: center;">$a < \text{Glass Thickness}$</td> </tr> </tbody> </table>	Length and Width	Acc. Qty	$c \leq 0.6, b < 5.0$	Ignore	$a < \text{Glass Thickness}$			
Length and Width	Acc. Qty									
$c \leq 0.6, b < 5.0$	Ignore									
$a < \text{Glass Thickness}$										
07	Glass Corner Chipping: (Minor defect) 玻璃切角:(小瑕疵) 	<table border="1" data-bbox="775 645 1246 846"> <thead> <tr> <th>Length and Width</th> <th>Acc. Qty</th> </tr> </thead> <tbody> <tr> <td>$c < 2.0, b < 1.5$</td> <td>Ignore</td> </tr> <tr> <td>$c < 1.5, b < 2$</td> <td>Ignore</td> </tr> <tr> <td colspan="2" style="text-align: center;">$a < \text{Glass Thickness}$</td> </tr> </tbody> </table>	Length and Width	Acc. Qty	$c < 2.0, b < 1.5$	Ignore	$c < 1.5, b < 2$	Ignore	$a < \text{Glass Thickness}$	
Length and Width	Acc. Qty									
$c < 2.0, b < 1.5$	Ignore									
$c < 1.5, b < 2$	Ignore									
$a < \text{Glass Thickness}$										
08	Glass Burr: (Minor defect) 玻璃磨:(小瑕疵) 	Glass burr don't affect assemble and module dimension. <table border="1" data-bbox="775 1093 1246 1193"> <thead> <tr> <th>Length</th> <th>Acc. Qty</th> </tr> </thead> <tbody> <tr> <td>$F < 0.5$</td> <td>Ignore</td> </tr> </tbody> </table>	Length	Acc. Qty	$F < 0.5$	Ignore				
Length	Acc. Qty									
$F < 0.5$	Ignore									
09	FPC Defect: (Minor defect) FPC 缺陷:(小瑕疵) 	9.1 Dent, pinhole width $a < w/3$. (w: circuitry width.) 9.2 Open circuit is unacceptable. 9.3 No oxidation, contamination and distortion.								
10	Screen deformation 屏幕上的变形 	Test for insertion of plug gauge at highest warping point: (3.1-6.0inches) $H \leq 0.3\text{MM}$ The client has special requirements, according to drawing								

No.	Item 项目	Criteria (Unit: mm) 标准										
11	Bubble on Polarizer (Minor defect) 偏光片上的气泡(小瑕疵)	<table border="1"> <thead> <tr> <th data-bbox="775 181 1058 230">Diameter</th> <th data-bbox="1058 181 1246 230">Acc. Qty</th> </tr> </thead> <tbody> <tr> <td data-bbox="775 230 1058 280">$\varphi \leq 0.15$</td> <td data-bbox="1058 230 1246 280">Ignore</td> </tr> <tr> <td data-bbox="775 280 1058 329">$0.15 < \varphi \leq 0.25$</td> <td data-bbox="1058 280 1246 329">2</td> </tr> <tr> <td data-bbox="775 329 1058 378">$0.25 < \varphi \leq 0.3$</td> <td data-bbox="1058 329 1246 378">1</td> </tr> <tr> <td data-bbox="775 378 1058 427">$0.3 < \varphi$</td> <td data-bbox="1058 378 1246 427">0</td> </tr> </tbody> </table>	Diameter	Acc. Qty	$\varphi \leq 0.15$	Ignore	$0.15 < \varphi \leq 0.25$	2	$0.25 < \varphi \leq 0.3$	1	$0.3 < \varphi$	0
Diameter	Acc. Qty											
$\varphi \leq 0.15$	Ignore											
$0.15 < \varphi \leq 0.25$	2											
$0.25 < \varphi \leq 0.3$	1											
$0.3 < \varphi$	0											
12	Dent on Polarizer (Minor defect) 偏光片上的凹痕(小瑕疵)	<table border="1"> <thead> <tr> <th data-bbox="775 456 1058 506">Diameter</th> <th data-bbox="1058 456 1246 506">Acc. Qty</th> </tr> </thead> <tbody> <tr> <td data-bbox="775 506 1058 555">$\varphi \leq 0.15$</td> <td data-bbox="1058 506 1246 555">Ignore</td> </tr> <tr> <td data-bbox="775 555 1058 604">$0.15 < \varphi \leq 0.25$</td> <td data-bbox="1058 555 1246 604">2</td> </tr> <tr> <td data-bbox="775 604 1058 654">$0.25 < \varphi \leq 0.30$</td> <td data-bbox="1058 604 1246 654">1</td> </tr> <tr> <td data-bbox="775 654 1058 703">$0.3 < \varphi$</td> <td data-bbox="1058 654 1246 703">0</td> </tr> </tbody> </table>	Diameter	Acc. Qty	$\varphi \leq 0.15$	Ignore	$0.15 < \varphi \leq 0.25$	2	$0.25 < \varphi \leq 0.30$	1	$0.3 < \varphi$	0
Diameter	Acc. Qty											
$\varphi \leq 0.15$	Ignore											
$0.15 < \varphi \leq 0.25$	2											
$0.25 < \varphi \leq 0.30$	1											
$0.3 < \varphi$	0											
13	Bezel 边框	13.1 No rust, distortion on the Bezel.										
14	Touch Panel 触控面板	<p>D: Diameter W: width L: length</p> <p>14.1 Spot: $D \leq 0.20$ is acceptable $0.20 < D \leq 0.3$, acceptable QTY, 3 $D > 0.3$ is unacceptable</p> <p>14.2 Dent (dot): $D \leq 0.20$ is acceptable $0.20 < D \leq 0.3$, acceptable QTY, 3 $D > 0.30$ is unacceptable</p> <p>2dots are acceptable and the distance between defects should more than 10 mm.</p> <p>Dent (line) According to the limit sample</p> <p>14.3 Scratch: $W \leq 0.03$, $L \leq 10$ is acceptable, $0.03 < W \leq 0.10$, $L \leq 10$, acceptable QTY, 3 $W > 0.10$ is unacceptable.</p> <p>Distance between 2 defects should more than 10 mm.</p>										
15	PCB	<p>15.1 No distortion or contamination on PCB terminals.</p> <p>15.2 All components on PCB must same as documented on the BOM/component layout.</p> <p>15.3 Follow IPC-A-600F.</p>										
16	Soldering 焊接	Follow IPC-A-610C standard										

No.	Item 项目	Criteria (Unit: mm) 标准
17	Electrical Defect (Major defect) 电气 缺陷(主要缺陷)	The below defects must be rejected. 17.1 Missing vertical / horizontal segment, 17.2 Abnormal Display. 17.3 No function or no display. 17.4 Current exceeds product specifications. 17.5 LCD viewing angle defect. 17.6 No Backlight. 17.7 Dark Backlight. 17.8 Touch Panel no function. 17.9 Dark Dot –one Allowed. 17.10 Bright Dot – one Allowed. Remark: 1. A pixel defect is acceptable if one color is none functional and causes a bright dot. The display may have one case where one color is out and cause a dark dot. 2. Bright dot caused by scratch and foreign object accords to item1.
18	Light leak 漏光	Yellow light OK; White light,According to the limit sample

Remark: Visual and cosmetic defects are rejectable only if these fall within the LCD viewing area.

10.5 Classification of Defects 缺陷的分类

Visual defects (Except no / wrong label) are treated as minor defect and electrical defect is major.

10.6 Identification/marketing criteria 识别/评分标准

Any unit with illegible / wrong /double or no marking/ label shall be rejected.

10.7 Packing 包装

10.7.1 There should be no damage of the outside carton box, each packaging box should has label in the correct location per packing drawing requirement.

10.7.2 All direct package materials shall offer ESD protection.

11 Reliability Specification 可靠性规范

Item 项目	Condition 条件	Cycle Time 周期时间	Quantity 数量	Remark 备注
Constant Temp. and Constant Humidity Operation Test 恒温恒湿运行试验	+40 ± 3°C,90 ± 3%RH	96hrs	--	*1
High Temp. Operation Test 高温操作试验	+70 ± 3°C	96hrs	--	
Low Temp. Operation Test 低温操作试验	-20 ± 3°C	96hrs	--	
Thermal Shock Test 热冲击试验	-20 ± 3°C (30min)	10cycles	--	

	+70 ± 3°C (30min)			
ESD Test(end product) ESD 测试 (最终产品)	150pF, 330Ω, ±2KV, Contact	10times	--	*2, *3
	150pF, 330Ω, ±6KV, Air			
Vibration Test(for packaging) 振动 测试(包装)	Frequency: 10Hz to 55Hz to 10Hz, Swing: 1.5mm, time: X, Y, Z each 2H.	6hrs	One inner carton	*4

Note 1. For humidity test, DI water should be used.

Inspection Standard: Inspect after 1-2hrs storage at room temperature, the sample shall be free from the following defects:

- Air bubble in the LCD
- Seal Leakage
- Non-display
- Missing Segment
- Glass Crack
- IDD is greater than twice initial value.
- Others as per QA Inspection Criteria

Note 2. No defect is allowed after testing

The End Product ESD value is only indicative and depends on customer ESD protection design for the whole system.

Note 3. ESD should be applied to LCD glass panel, not other areas (such as on IC and so on) IDD should be within twice initial value.

In case of malfunction defect caused by ESD damage, if it would be recovered to normal state after resetting, it would be judged as a good part.

Note 4. Only upon request.

12 Precautions and Warranty 注意事项和保证

12.1 Safety 安全

12.1.1 The liquid crystal in the LCD is poisonous. Do not put it in your mouth. If the liquid crystal touches your skin or clothes, wash it off immediately using soap and water.

12.1.2 Since the liquid crystal cells are made of glass, do not apply strong impact on them.

Handle with care.

12.2 Handling 处理

12.2.1 Reverse and use within ratings in order to keep performance and prevent damage.

12.2.2 Do not wipe the polarizer with dry cloth, as it might cause scratch. If the surface of the LCD needs to be cleaned, wipe it swiftly with cotton or other soft cloth soaked with petroleum IPA, do not use other chemicals.

12.3 Operation 操作

12.3.1 Do not drive LCD with DC voltage

12.3.2 Response time will increase below lower temperature

12.3.3 Display may change color with different temperature

12.3.4 Mechanical disturbance during operation, such as pressing on the display area, may

cause the segments to appear “fractured”.

12.4 Static Electricity 静电

12.4.1 CMOS LSIs are equipped in this unit, so care must be taken to avoid the electro-static charge, by ground human body, etc.

12.4.2 The normal static prevention measures should be observed for work clothes and benches.

12.4.3 The module should be kept into anti-static bags or other containers resistant to static for storage.

12.5 Limited Warranty 有限质量保证

12.5.1 Unless otherwise agreed between Tailorpixels and customer, Tailorpixels will replace or repair any of its LCD and LCM which Tailorpixels found to be defective electrically and visually when inspected in accordance with Tailorpixels Quality Standards , for a period of one year from date of shipment.

12.5.2 The warranty liability of Tailorpixels is limited to repair and/or replacement. Tailorpixels will not be responsible for any consequential loss.

12.5.3 If possible, we suggest you use up all modules in six months. If the module storage time over twelve months, we suggest that recheck it before the module be used.

13 Packaging 包装

TBD

14 Prior Consult Matter 免责声明

1. For Tailorpixels standard products, we keep the right to change material, process for improving the product property without prior notice to our customer.

2. For OEM products, if any changes are needed which may affect the product property, we will consult with our customer in advance.

3. If you have special requirement about reliability condition, please let us know before you start the test on our samples.

Reference 参考

Item 项目	Description 描述	Revision 修订
CO5300	IC Data sheet	V0
Panel 2.16 寸 480X480	LCM assembly drawing	V1